

Keedex Key Decoder, Guards, Template, Protectors

Keedex



GM Key Decoder



- Decodes all tumblers in one step without complete disassembly of the lock.
- Made of Lexan® with stainless steel fingers, and durable aluminum card.
- Instructions and case included.
- Guaranteed for life.

Mfg #	EZ #
K4 *KEDX*	026672

Cylinder Guard Rings

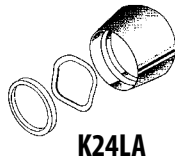
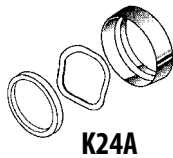

- Hardened steel free spinning and tapered cone-shaped cylinder guard ring
- Protects mortise & rim cylinders against wrenching
- Durable powder coat finish
- K24A & K24LA are packed with stainless steel wave washers, & spacing collars.

Mfg #	Cylinder Length	Finish	With Washer & Collar	Mfg #
K24A [KEDX]	1" to 1-1/8"	Aluminum	Yes	025686
K24LA	1-1/4" to 1-3/8"	Aluminum	Yes	072692
K24SPA	1" to 1-1/8"	Aluminum	No	035852
K24SPB	1" to 1-1/8"	Duronodic	No	035853

Double Aluminum Door Stile Guard

- For securing sets of double aluminum doors.
- 12 Gauge steel construction increases security and can repair doors that have already been attacked.
- Designed with a "knock out" to accommodate Adams Rite MS Bolt.
- Baked on powder coat finish.



Mfg #	Finish	EZ #
K15A	Aluminum	029038
K15B	Duronodic	029039

Aluminum Door Offset Stile Guard



- For reinforcing or repairing jambs with offset hung aluminum doors.
- Non-handed guard is easy to install and includes pop rivets and carriage bolts.
- Baked on powder coat finish.

Mfg #	EZ #
K20A	029040

Adams Rite Router Installation Template

- Make precise installations of Adams Rite 1850S, 4530, 4710 & 4711 series locks.
- For 7/8", 31/32" & 1 1/8" backsets.
- Includes guide for Adams Rite exit indicator 4089.
- Has cutout for BBW #3925 & International FB-1200 flush bolts.
- For 1/2" router guide with a 1/4" bit.

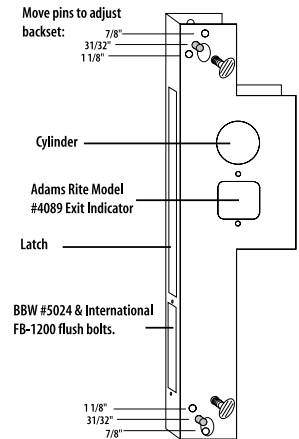

Mfg #	EZ #
TMPAR	035849

Knob & Lever Protector

- Protect-A-Lok is made from Lexan® poly carbonate which is virtually indestructible.
- For use in areas where locks may have a chance of getting hit by carts, forklifts or vehicles.
- Installs in minutes.

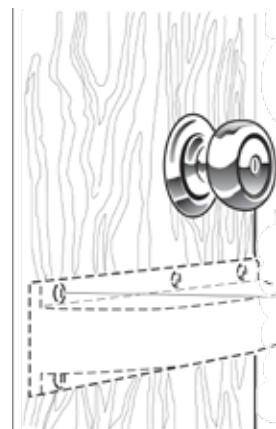

Mfg #	Finish	EZ #
K12	Cream	008210
K12D	Duronodic	008211

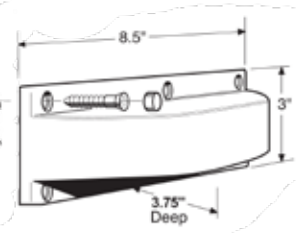

Armoured Door Loop

- 1/4" Flexible stainless steel conduit
- Stainless steel end pieces and mounting screws
- For transfer of low-voltage electrical current from the door to the door frame.

Mfg #	Length	EZ #
K DS	18"	078599
K DS12	12"	085452

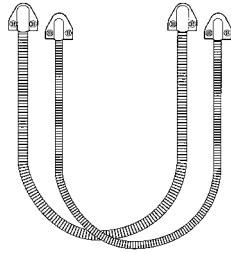

Speedo 12VDC Motor

- 1/4 h.p. Motor works with a wide variety of key machines
- 3800 R.P.M. High torque 12 volt D.C. motor is an energy efficient permanent magnet design.
- Supplied with bronze bearings, pulley, mounting bracket & belt
- Reversing power leads allows you to reverse shaft rotation.

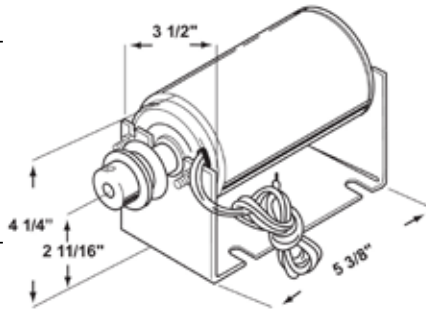

Mfg #	Description	EZ #
K5 [KEDX]	12VDC Motor	026673
K5BLT	Replacement Belt	035851

Master Following Tool



Mfg #	EZ #
K6	029042

- Made of solid brass this machined follower can be used as a regular follower, or as a master pin remover
- Special taper allows smooth operation and better control over sticking pins than conventional followers.

Lever Opening Tool

Mfg #	EZ #
K22	028239

- For opening lever handle locks where a gap exists under the door.



Tamper Proof Screws

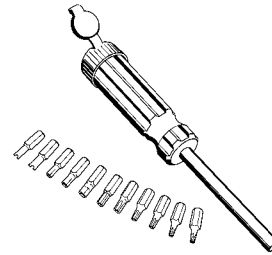

- Screwdriver comes with eleven interchangeable tips. Includes the following:
- Two Spanner Tips (#6 & #8).
 - Six tamper resistant torx tips (T10, T15, T20, T25, T27 & T30).
 - Three tamper resistant hex tips (5/32", 3/16" & 7/32").
 - All tips fit into the screwdriver's storage handle

- Contains 12 each, of 14 different sizes of machine and wood/metal Tamper Resistant stainless steel screws,
- Also includes six different sizes of Spanner Driver Bits.
- The storage case has movable dividers, so you can configure it based on your usage.

Mfg #	Description	EZ #
SSKIT	Tamper Screw Kit	085453
TAMPER	Tamper Resistant Screwdriver	065067

Safe Change Key Set

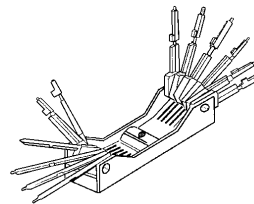

- Set of twelve of the most common change keys in a handy case.
- Keys fold out "knife style" to select the proper tool.
- Case is engraved with description of uses.
- Keys are made of stainless steel.

Mfg #	EZ #
K18 [KEDX]	008214

- Mosler 35-4 wheel
- Mosler 302-3 wheel
- S & G Amsec 3 wheel
- S & G 6720-3 wheel
- Diebold 180-3 wheel
- Diebold 177-4 wheel
- S & G padlock 3 wheel
- S & G 4163
- LaGard R1-1 wheel
- LaGard 3 wheel
- LaGard 4 wheel
- LaGard & Amsec 3 wheel

Safe Repair Kit

- For repairing safes that have been drilled open
- Five sizes of taper pins milled from bar steel to repair drill holes from 1/8" to 1/2".
- Four sizes of corresponding ball bearings to complete a professional repair.



Mfg #	EZ #
K16	008213



Carbide Tip Drill Bits

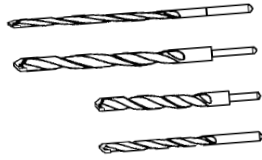

Mfg #	Diameter	Length	EZ #
144	1/4"	4"	008220
146	1/4"	6"	008221
384	3/8"	4"	008222
386	3/8"	6"	008223

- High quality specially sharpened on a diamond wheel.
- Ideal for penetrating hard plate and other demanding metal work.

Inspection Scope

- Transforms mini flashlight into a powerful inspection device.
- Works with Mini-Mag Lite®, and many other "AA" flashlights.
- Consists of a 1" diameter poly propylene cap and two interchangeable fiber optic rods; one 45° and one 90°.



Mfg #	EZ #
K23	028240

iCan Access Control Housing

- 14 Gauge welded steel enclosure
- Durable black powder coat finish on housing
- 18 Gauge Stainless steel face plate with tubular key lock
- Accepts two single gang devices to install an intercom & keypad, prox reader & key switch, or a keypad & key switch.
- Allows multiple access types for municipal service agencies.
- Dimensions: 9-1/2"W x 5"H x 3-3/8"D

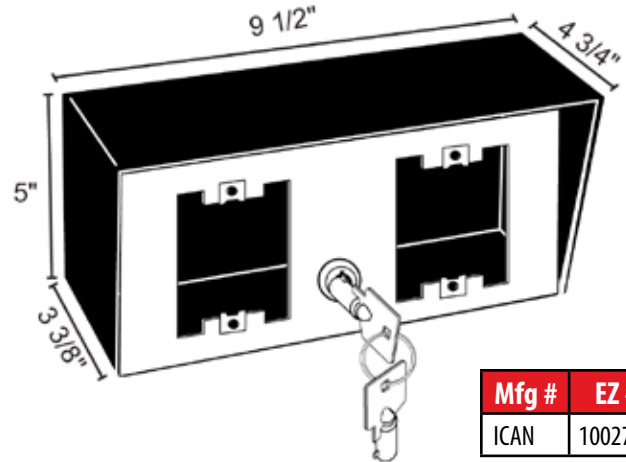

Mfg #	EZ #
ICAN	100272

Weldable Gate Boxes

- 14 Gauge box to install locks, exit devices, & electric strikes on gates.

Mfg #	Application	Size (H x L x W)	EZ #
K BXSGL234	Single Key-in-Knob/Deadbolt, 2-3/4" Backset	3-1/2 x 4-3/4 x 1-5/8	035848
K BXSGL	Single Key-in-Knob/Deadbolt, 2-3/8" Backset	3-1/2 x 4-1/2 x 1-5/8	068179
K BXDBL	Double Key-in-Knob/Deadbolt, 2-3/8" Backset	6-7/8 x 4-1/2 x 1-1/2	029034
K BXA/R	Adams Rite 4500/4700/4900 1-1/8" Deadlatch	7 x 2-1/16 x 1-13/16	029033
K BXES10	Von Duprin 6215/6226, Folger Adam 310-2	12 x 2 x 2-7/16	100262
K BXES2	Adams Rite 7170, Eff Eff Strike 4 & 7 Series, RCI 4104, 7104	5-1/16 x 2-3/8 x 1-3/4	029036
K BXES3A	Adams Rite 7100/7140/7160, HES 5000 with 501 Option	5-1/16 x 2-3/8 x 1-3/4	029043
K BXES4	Folger Adam 712/712-75, Von Duprin 3140/6211	6-9/16 x 2-3/8 x 2	035847
K BXES5	HES 1003/1006	5-1/16 x 2-3/8 x 1-3/4	100263
K BXMOR1	Sargent 7700/8100, Schlage L, Yale 46/8700	8-1/8 x 4-5/8 x 1 3/4	100266
K BXMOR2	Corbin ML2000, Falcon M, Best 34	8-1/8 x 4-5/8 x 1 3/4	100267
K BXSIM	Kaba Simplex 1000, 5000, Eplex 5X00, Alarm Lock Trilogy	9-1/4 x 5-1/2 x 1-3/4	029037
K BXSIM 7004	Kaba Simplex 7000/7100		100265
K BXE2000	Kaba Eplex 2000		100264
K BXC0B	Schlage/Locknetics Cobra	10-1/2 x 5-1/2 x 1-3/4	079045
K BXED V990NL	Von Duprin 99 with 990NL Trim	15 x 5 x 1-3/4	100268
K BXED V992L	Von Duprin 992L Trim	15 x 5 x 1-3/4	100269

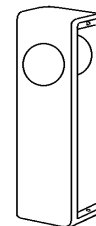

K BXA/R

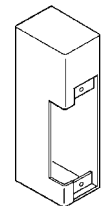

K BXES3A

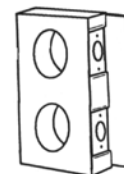

K BXDBL

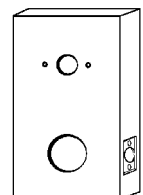

K BXSIM

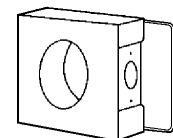

K BXSGL